

SCALE 1:30

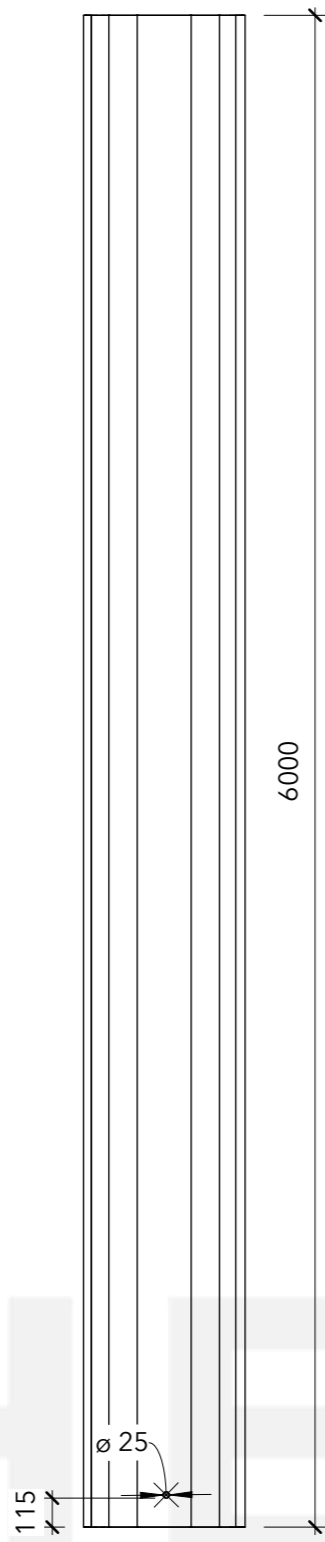

SCALE 1:30

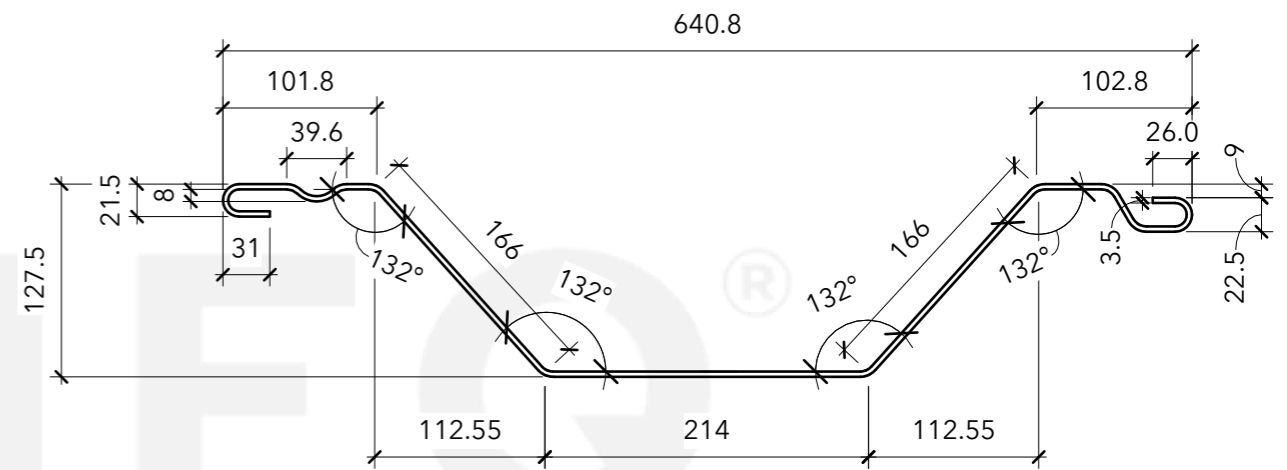

SCALE 1:5

General Comments

See Our Associated Accessories:
[Standard Driving Cap](#)
[Trench Sheet Extractors](#)
[Pitching Shackles](#)
 See Our Associated Products:
[Trench Sheets - FLP 600/3.5](#)
[Trench Sheets - Standard Lap](#)
[Trench Sheets - KKD 600/6](#)
[Sheet Piles - FKD 400/6 - KD4](#)

Materials

Mild Steel - Grade S275



No.	Description	Date

Item	Component Description	Quantity

TRENCH SHEET - FLP 600/3.5 6000MM			
Weight	138.6KG	Serial Number	Revision
Date	13/11/2023	TR1767	
Drawn by	JT		
Checked by	Checker	Scale	As indicated @A3